

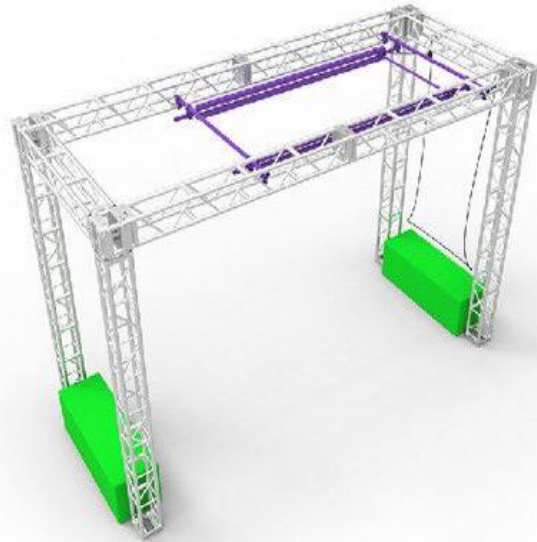

# OBSTACLE LIST

GOOD

EQUIPMENT



#### DIFFICULTY

NOVICE

INTERMEDIATE

EXPERT

#### AGE

KID

TEEN

ADULT

#### FOCUS

BALANCE

LOWER

UPPER

## Pipe Slider

Code	FS-01
Adapted Frame	2*5M
Truss Frame	Not Include
Foam	Not Include



# Camel Back

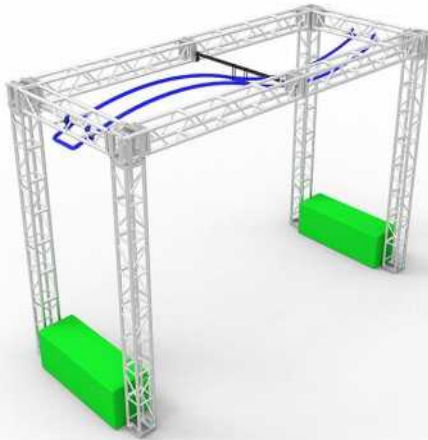

### DIFFICULTY

NOVICE
  INTERMEDIATE
  EXPERT

### AGE

KID
  TEEN
  ADULT

### FOCUS

BALANCE
  LOWER
  UPPER

<b>Code</b>	FS-2
<b>Adapted Frame</b>	2*5M
<b>Truss Frame</b>	Not Include
<b>Foam</b>	Not Include







# Jungle Swing

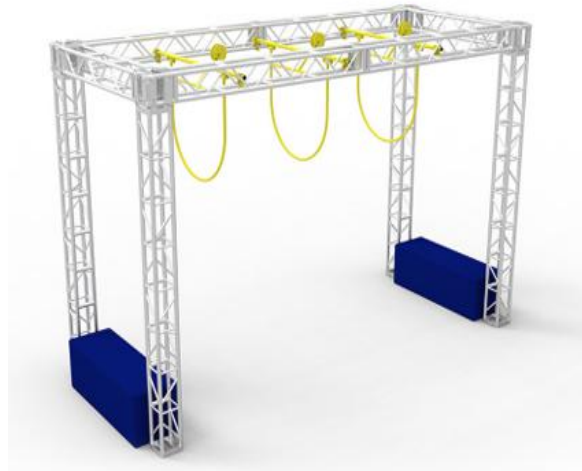

## DIFFICULTY

NOVICE

INTERMEDIATE

EXPERT

## AGE

KID

TEEN

ADULT

## FOCUS

BALANCE

LOWER

UPPER

<b>Code</b>	FS-03
<b>Adapted Frame</b>	2*5M
<b>Truss Frame</b>	Not Include
<b>Foam</b>	Not Include







TUV NORD  
EN 1090-1, -3

NINJA  
WARRIOR  
DESIGN

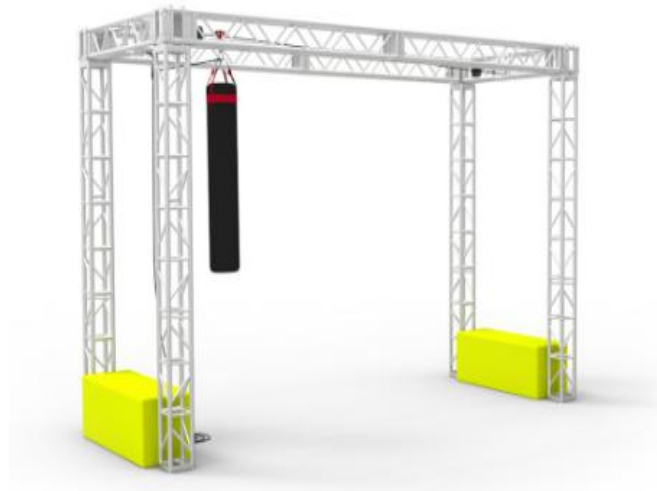

#### DIFFICULTY

NOVICE

INTERMEDIATE

EXPERT

#### AGE

KID

TEEN

ADULT

#### FOCUS

BALANCE

LOWER

UPPER

## Log Grip

Code	FS-04
Adapted Frame	2*5M
Truss Frame	Not Include
Foam	Not Include





TUV NORD  
EN 1090-1, -3

NINJA  
WARRIOR  
DESIGN

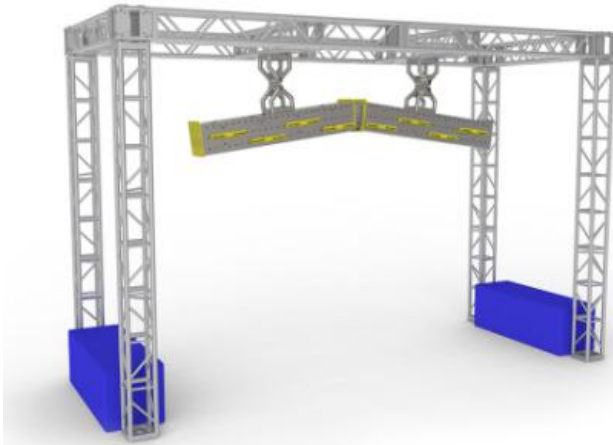

#### DIFFICULTY

NOVICE

INTERMEDIATE

EXPERT

#### AGE

KID

TEEN

ADULT

#### FOCUS

BALANCE

LOWER

UPPER

## Traverse Box

Code	FS-05
Adapted Frame	2*5M
Truss Frame	Not Include
Foam	Not Include







# Ring Slider

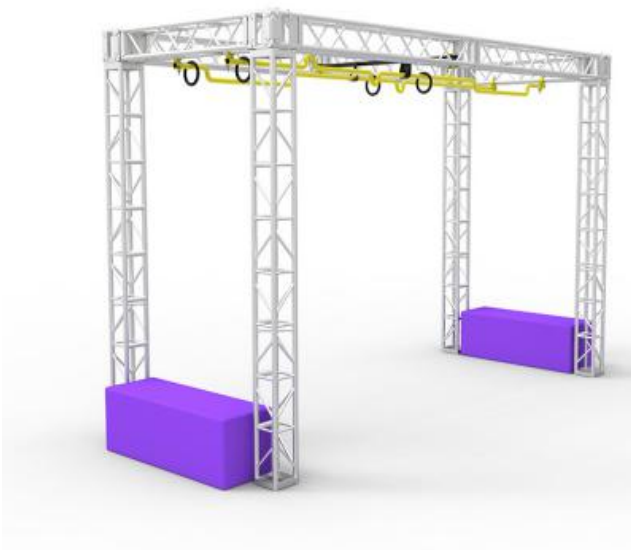

### DIFFICULTY

- NOVICE
- INTERMEDIATE
- EXPERT**

### AGE

- KID
- TEEN
- ADULT**

### FOCUS

- BALANCE
- LOWER
- UPPER**

<b>Code</b>	FS-06
<b>Adapted Frame</b>	2*5M
<b>Truss Frame</b>	Not Include
<b>Foam</b>	Not Include







# Rope Traverse

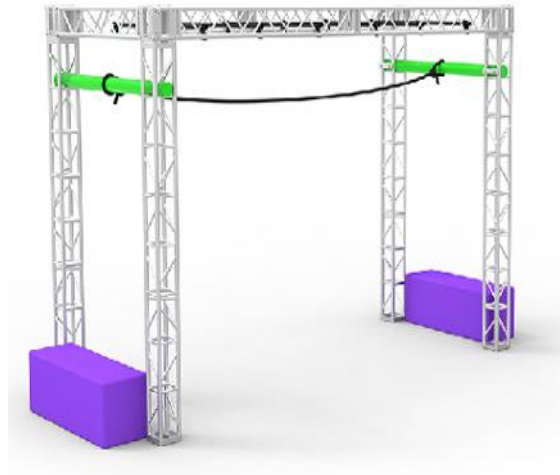

## DIFFICULTY

NOVICE

**INTERMEDIATE**

EXPERT

## AGE

**KID**

TEEN

ADULT

## FOCUS

**BALANCE**

LOWER

UPPER

<b>Code</b>	FS-07
<b>Adapted Frame</b>	2*5M
<b>Truss Frame</b>	Not Include
<b>Foam</b>	Not Include





**NINJA  
WARRIOR  
DESIGN**



#### DIFFICULTY

NOVICE INTERMEDIATE **EXPERT**

#### AGE

KID **TEEN** ADULT

#### FOCUS

BALANCE LOWER **UPPER**

## Bungee Cord

<b>Code</b>	FS-08
<b>Adapted Frame</b>	2*5M
<b>Truss Frame</b>	Not Include
<b>Foam</b>	Not Include







**NINJA  
WARRIOR  
DESIGN**

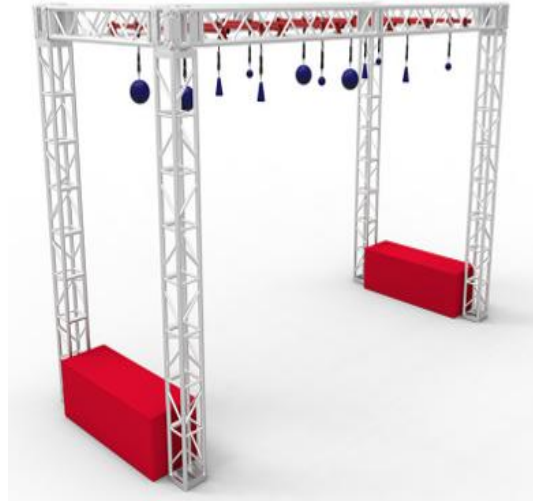

### DIFFICULTY

- NOVICE
- INTERMEDIATE
- EXPERT**

### AGE

- KID
- TEEN
- ADULT**

### FOCUS

- BALANCE
- LOWER
- UPPER**

# Cannonball

<b>Code</b>	FS-09
<b>Adapted Frame</b>	2*5M
<b>Truss Frame</b>	Not Include
<b>Foam</b>	Not Include







#### DIFFICULTY

NOVICE

INTERMEDIATE

EXPERT

#### AGE

KID

TEEN

ADULT

#### FOCUS

BALANCE

LOWER

UPPER

# Swinging

Code	FS-10
Adapted Frame	2*5M
Truss Frame	Not Include
Foam	Not Include





# Swinging Frame

## DIFFICULTY

- NOVICE
- INTERMEDIATE
- EXPERT**

## AGE

- KID
- TEEN**
- ADULT

## FOCUS

- BALANCE
- LOWER
- UPPER**

Code	FS-11
<b>Adapted Frame</b>	2*5M
<b>Truss Frame</b>	Not Include
<b>Foam</b>	Not Include







**NINJA  
WARRIOR  
DESIGN**

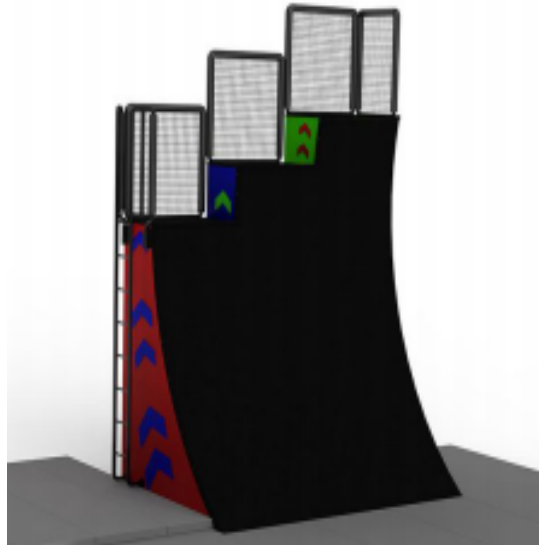

**DIFFICULTY**

NOVICE

INTERMEDIATE

EXPERT

**AGE**

KID

TEEN

ADULT

**FOCUS**

BALANCE

LOWER

UPPER

# Warped Wall

<b>Code</b>	FS-12
<b>Common Need</b>	2 - 3 Lanes
<b>Truss Frame</b>	Not Include
<b>Foam</b>	Not Include







TUV NORD  
EN 1090-1, -3

NINJA  
WARRIOR  
DESIGN

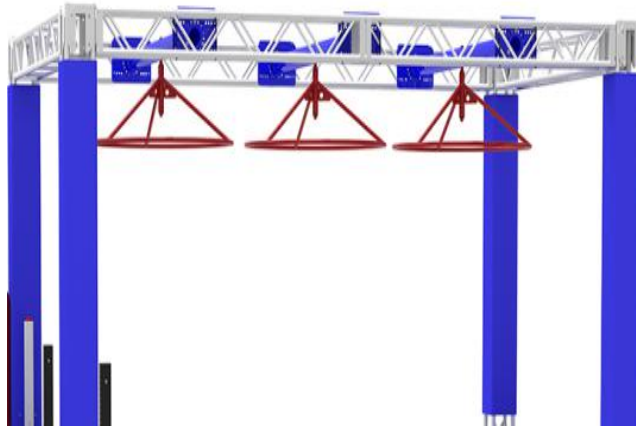

#### DIFFICULTY

NOVICE INTERMEDIATE **EXPERT**

#### AGE

KID **TEEN** ADULT

#### FOCUS

BALANCE LOWER **UPPER**

## Spin Cycle

Code	FS-13
Adapted Frame	2*5M
Truss Frame	Not Include
Foam	Not Include





TUV NORD  
EN 1090-1, -3

NINJA  
WARRIOR  
DESIGN

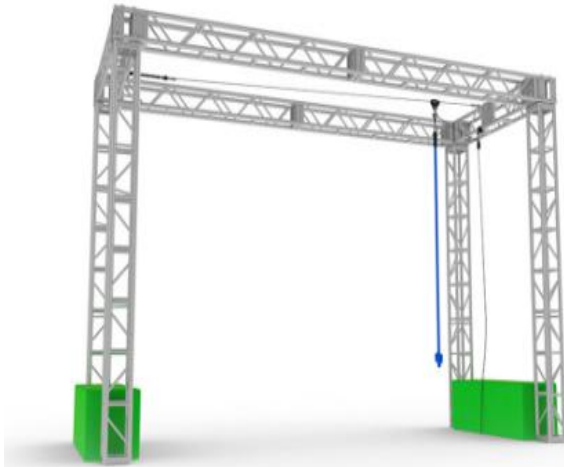

#### DIFFICULTY

NOVICE

INTERMEDIATE

EXPERT

#### AGE

KID

TEEN

ADULT

#### FOCUS

BALANCE

LOWER

UPPER

# Zip Line

Code	FS-14
Adapted Frame	2*5M
Truss Frame	Not Include
Foam	Not Include







TUV NORD  
EN 1090-1, -3

NINJA  
WARRIOR  
DESIGN

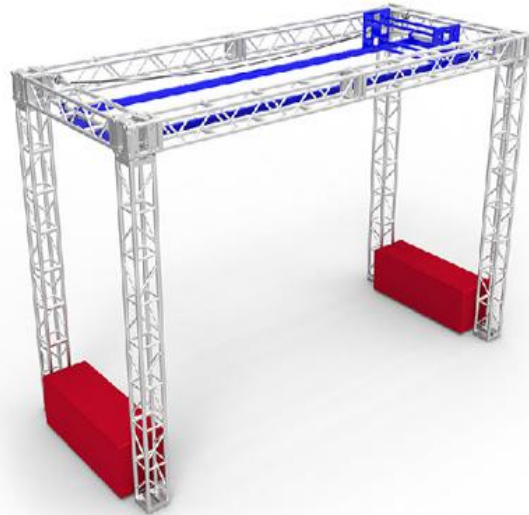

#### DIFFICULTY

NOVICE

INTERMEDIATE

EXPERT

#### AGE

KID

TEEN

ADULT

#### FOCUS

BALANCE

LOWER

UPPER

# Rumbling Dice

Code	FS-15
Adapted Frame	2*5M
Truss Frame	Not Include
Foam	Not Include







# Spinning Wheels -

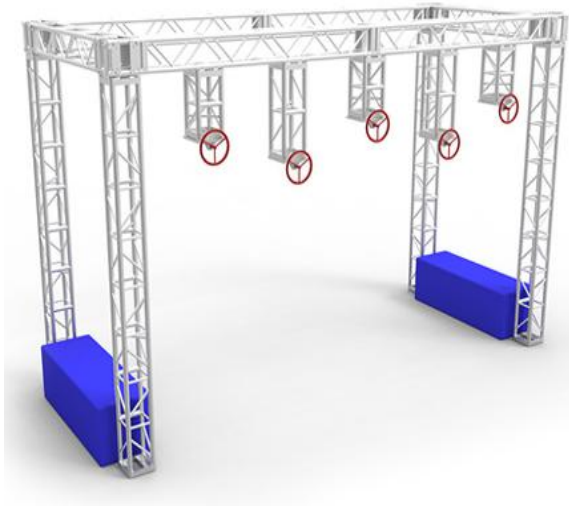

### DIFFICULTY

- NOVICE
- INTERMEDIATE**
- EXPERT

### AGE

- KID
- TEEN**
- ADULT

### FOCUS

- BALANCE
- LOWER
- UPPER**

<b>Code</b>	FS-16
<b>Assemble on</b>	Beam
<b>Truss Frame</b>	Not Include
<b>Foam</b>	Not Include





# Peg Maze

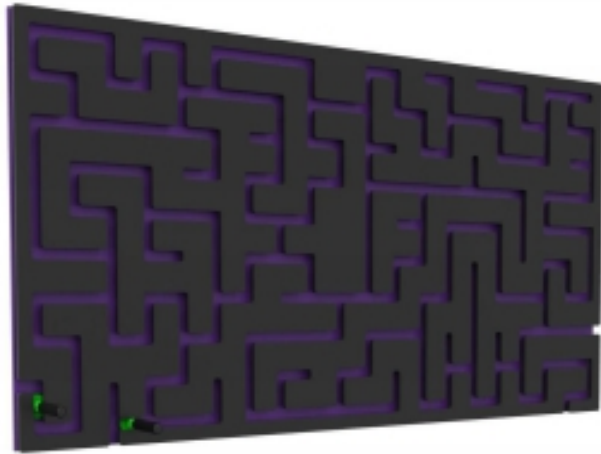

### DIFFICULTY

NOVICE    INTERMEDIATE    **EXPERT**

### AGE

KID    TEEN    **ADULT**

### FOCUS

BALANCE    LOWER    **UPPER**

<b>Code</b>	FS-17
<b>Assembled on</b>	Wall
<b>Truss Frame</b>	Not Include
<b>Foam</b>	Not Include

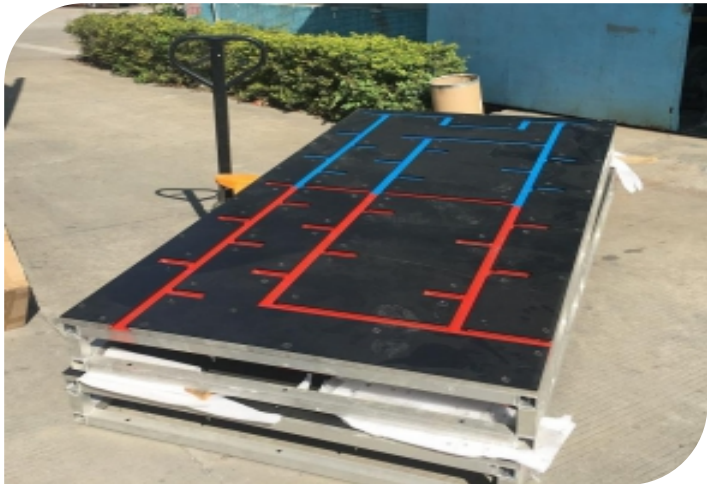
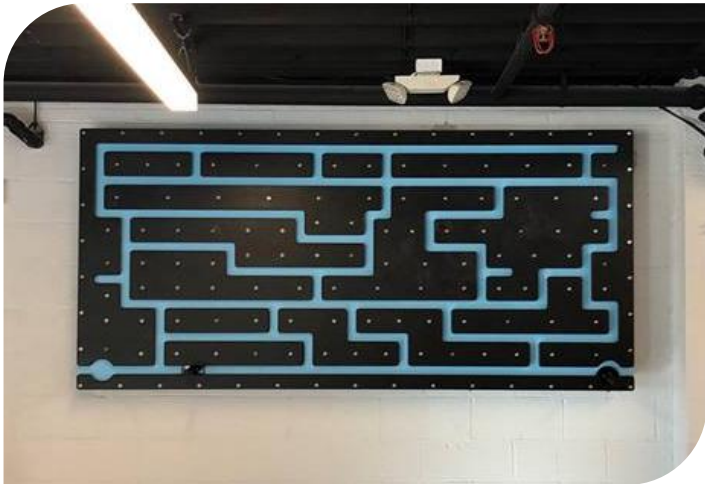





# Spindle Roller

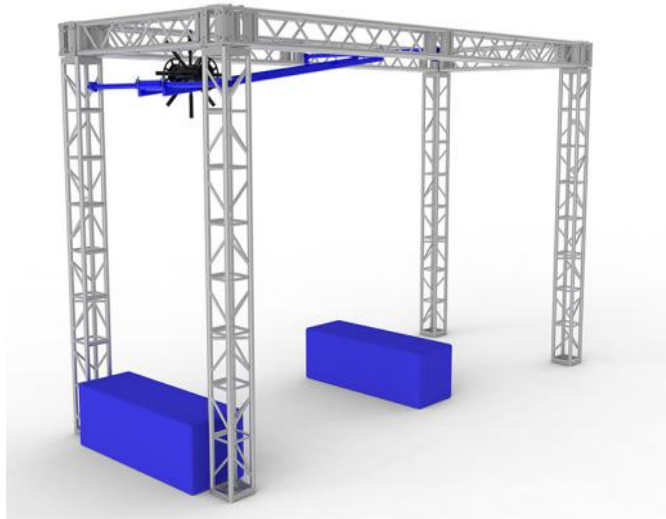

## DIFFICULTY

NOVICE

INTERMEDIATE

EXPERT

## AGE

KID

TEEN

ADULT

## FOCUS

BALANCE

LOWER

UPPER

<b>Code</b>	FS-18
<b>Adapted Frame</b>	2*5M
<b>Truss Frame</b>	Not Include
<b>Foam</b>	Not Include





# Devil Ladder



## DIFFICULTY

NOVICE

INTERMEDIATE

EXPERT

## AGE

KID

TEEN

ADULT

## FOCUS

BALANCE

LOWER

UPPER

<b>Code</b>	FS-19
<b>Adapted Frame</b>	2*5M
<b>Truss Frame</b>	Not Include
<b>Foam</b>	Not Include

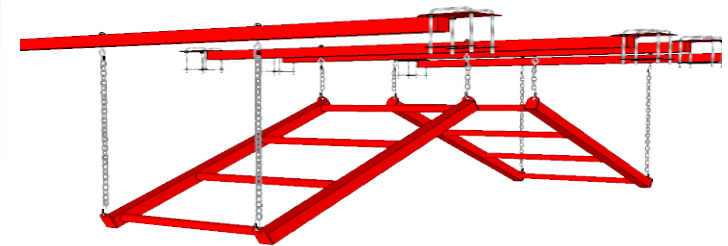
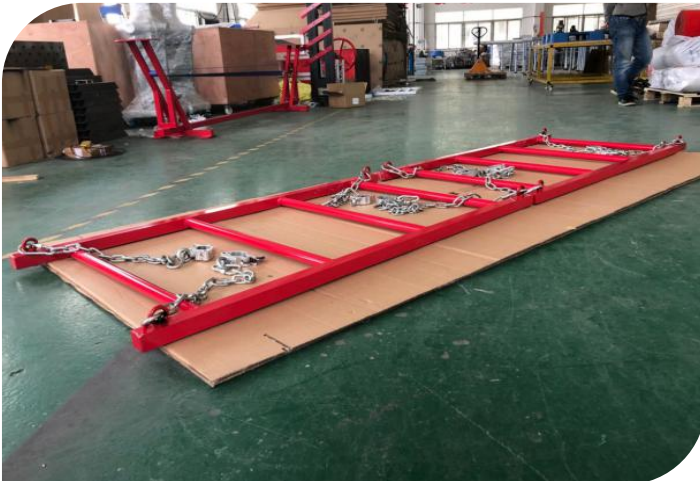





**NINJA  
WARRIOR  
DESIGN**

# Salmon Ladder



### DIFFICULTY

NOVICE INTERMEDIATE **EXPERT**

### AGE

KID **TEEN** ADULT

### FOCUS

BALANCE LOWER **UPPER**

<b>Code</b>	FS-20
<b>Adapted Frame</b>	2*5M
<b>Truss Frame</b>	Not Include
<b>Foam</b>	Not Include

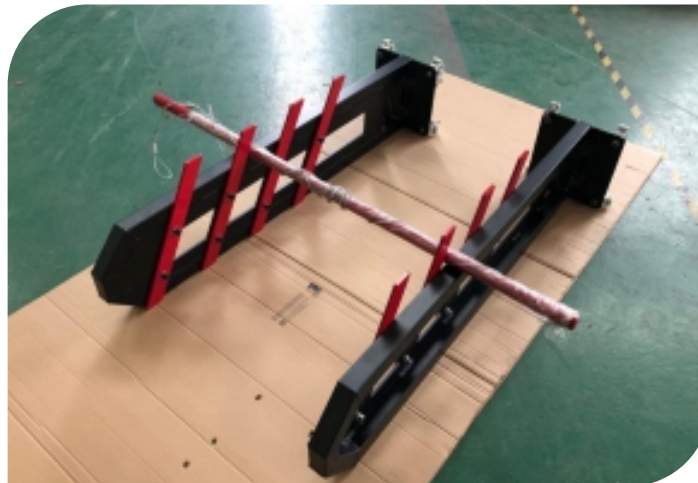



TUV NORD  
EN 1090-1, -3

NINJA  
WARRIOR  
DESIGN

# Spider Jump-B

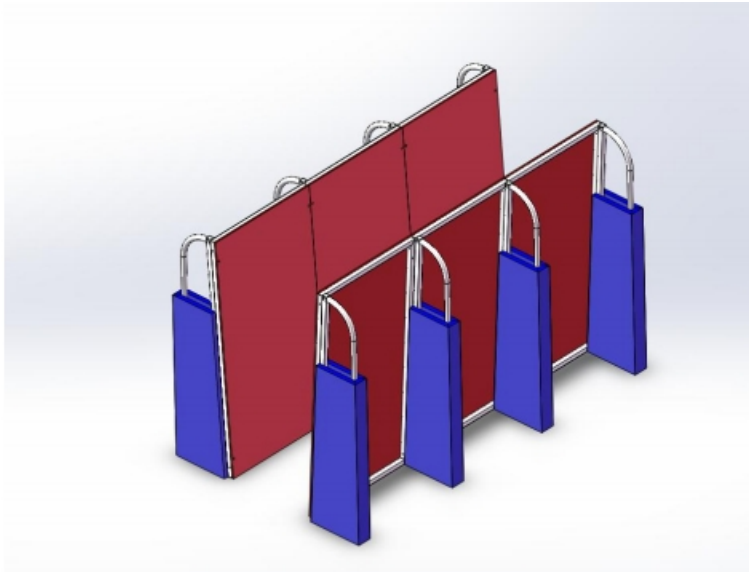

## DIFFICULTY

NOVICE

INTERMEDIATE

EXPERT

## AGE

KID

TEEN

ADULT

## FOCUS

BALANCE

LOWER

UPPER

Code	FS-21
Adapted Frame	2*5M
Truss Frame	Not Include
Foam	Not Include

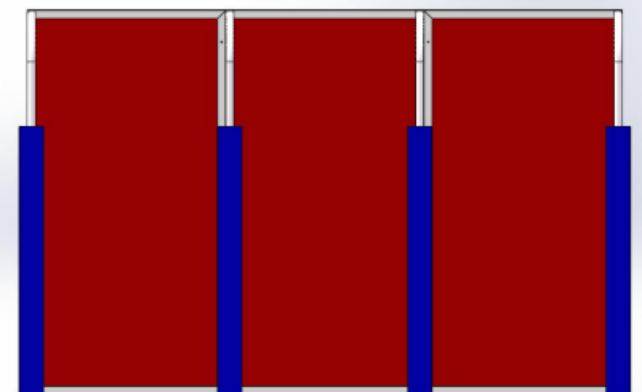
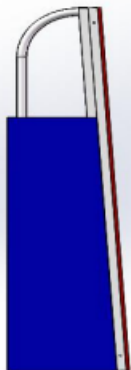





# UFO

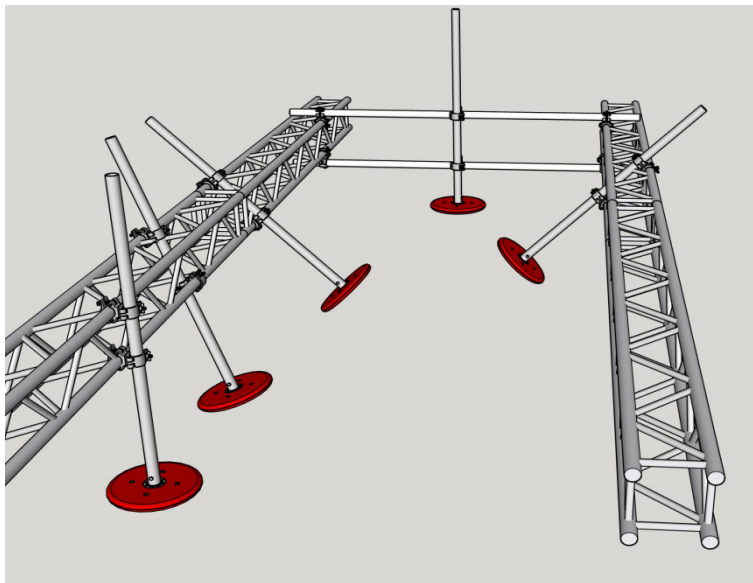

### DIFFICULTY

NOVICE INTERMEDIATE **EXPERT**

### AGE

KID **TEEN** ADULT

### FOCUS

BALANCE LOWER **UPPER**

<b>Code</b>	FS-22
<b>Adapted Frame</b>	2*5M
<b>Truss Frame</b>	Not Include
<b>Foam</b>	Not Include

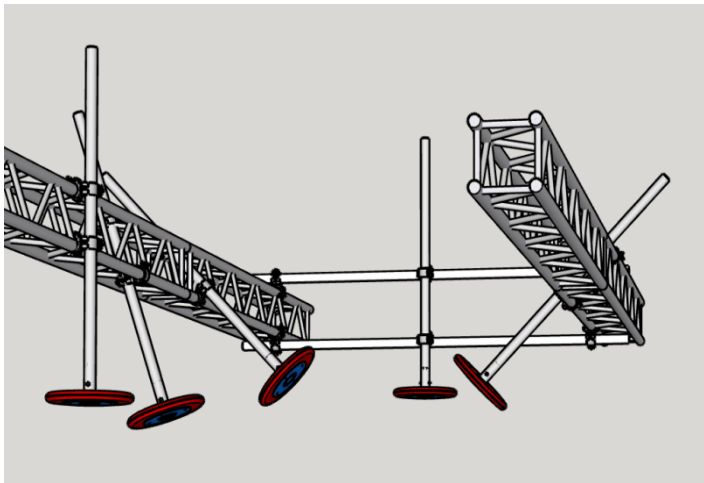
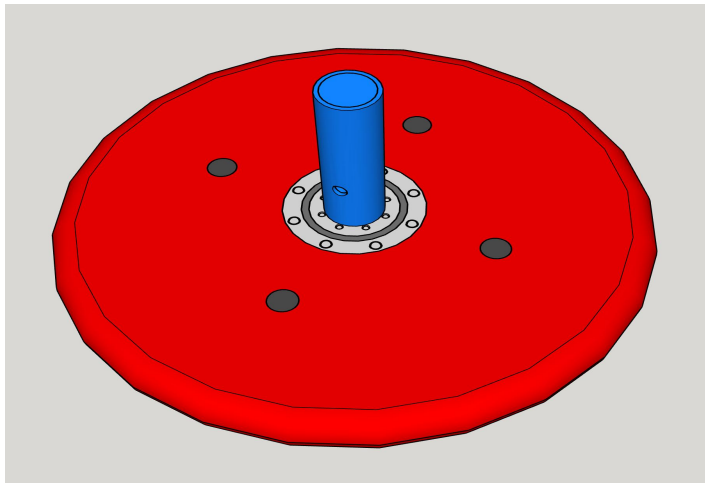



TUV NORD  
EN 1090-1, -3

NINJA  
WARRIOR  
DESIGN

# Sea of Pole

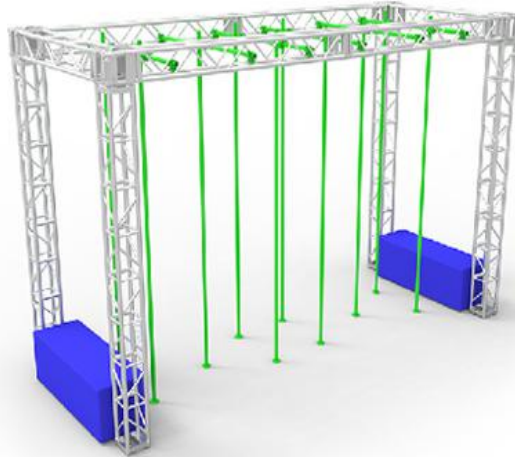

## DIFFICULTY

NOVICE

INTERMEDIATE

EXPERT

## AGE

KID

TEEN

ADULT

## FOCUS

BALANCE

LOWER

UPPER

Code	FS-23
Adapted Frame	2*5M
Truss Frame	Not Include
Foam	Not Include







# Horizontal Cargo

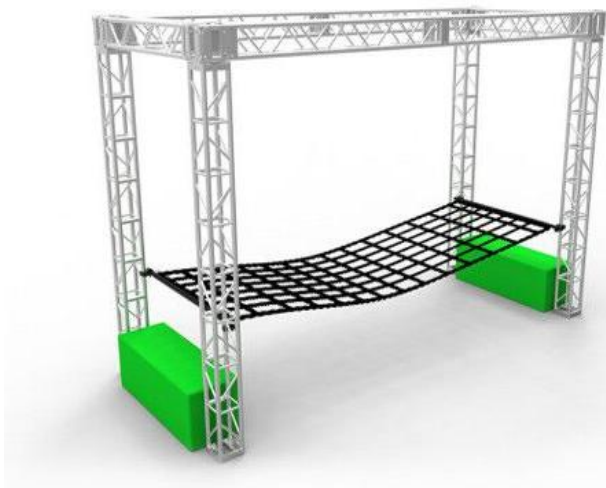

## DIFFICULTY

NOVICE

INTERMEDIATE

EXPERT

## AGE

KID

TEEN

ADULT

## FOCUS

BALANCE

LOWER

UPPER

<b>Code</b>	FS-24
<b>Adapted Frame</b>	2*5M
<b>Truss Frame</b>	Not Include
<b>Foam</b>	Not Include





# Horizontal Tube

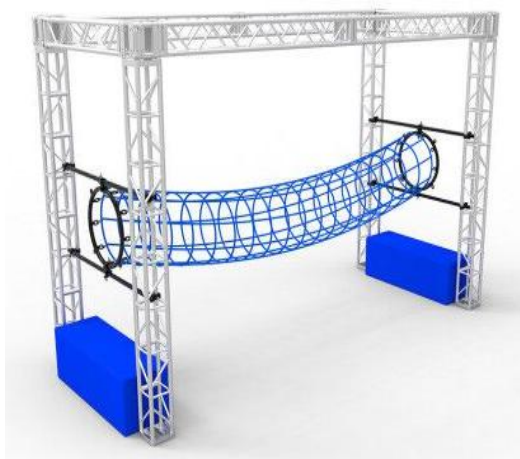

## DIFFICULTY

NOVICE

INTERMEDIATE

EXPERT

## AGE

KID

TEEN

ADULT

## FOCUS

BALANCE

LOWER

UPPER

Code	FS-25
Adapted Frame	2*5M
Truss Frame	Not Include
Foam	Not Include







TUV NORD  
EN 1090-1, -3

NINJA  
WARRIOR  
DESIGN

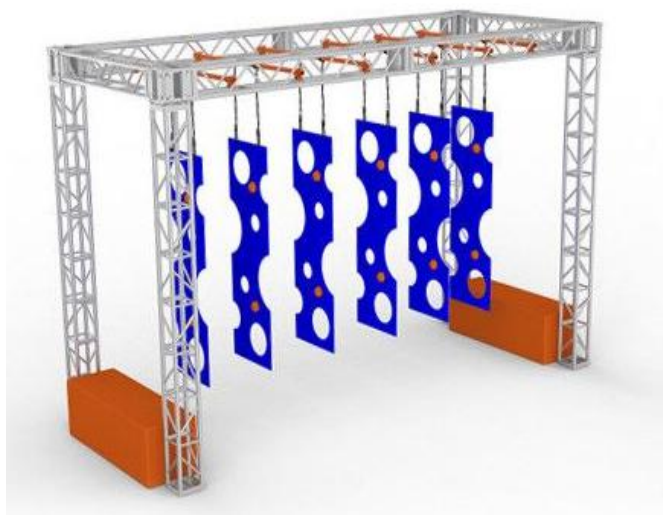

#### DIFFICULTY

NOVICE

INTERMEDIATE

EXPERT

#### AGE

KID

TEEN

ADULT

#### FOCUS

BALANCE

LOWER

UPPER

## Hanging Door

Code	FS-26
Common Need	4 PCS
Truss Frame	Not Include
Foam	Not Include



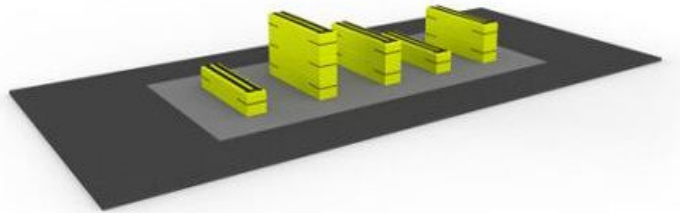

#### DIFFICULTY

NOVICE

INTERMEDIATE

EXPERT

#### AGE

KID

TEEN

ADULT

#### FOCUS

BALANCE

LOWER

UPPER

## Parkour Steps

<b>Code</b>	FS-27
<b>Adapted Frame</b>	2*5M
<b>Truss Frame</b>	Not Include
<b>Foam</b>	Not Include







TUV NORD  
EN 1090-1, -3

NINJA  
WARRIOR  
DESIGN

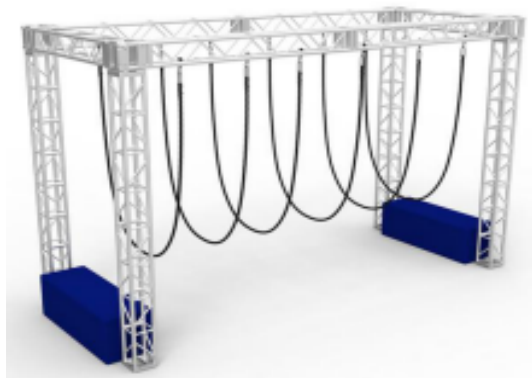

#### DIFFICULTY

NOVICE

INTERMEDIATE

EXPERT

#### AGE

KID

TEEN

ADULT

#### FOCUS

BALANCE

LOWER

UPPER

## U-Rope Walk

<b>Code</b>	FS-28
<b>Adapted Frame</b>	2*5M
<b>Truss Frame</b>	Not Include
<b>Foam</b>	Not Include





TUV NORD  
EN 1090-1, -3

NINJA  
WARRIOR  
DESIGN

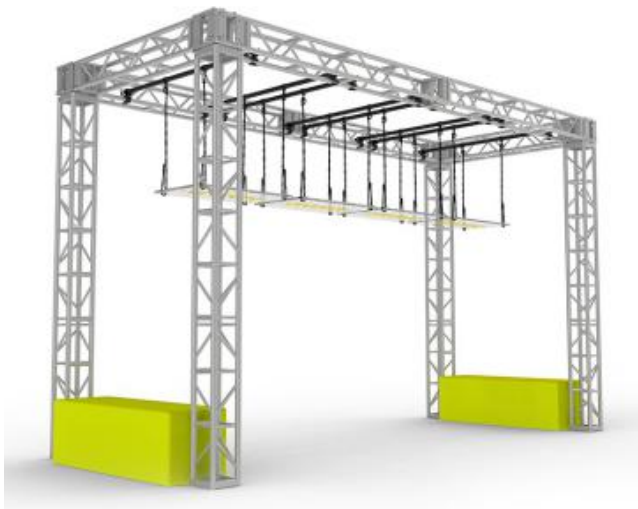

#### DIFFICULTY

NOVICE

INTERMEDIATE

EXPERT

#### AGE

KID

TEEN

ADULT

#### FOCUS

BALANCE

LOWER

UPPER

## Unstable Bridge

Code	FS-29
Adapted Frame	2*5M
Truss Frame	Not Include
Foam	Not Include







# Sea of Discs

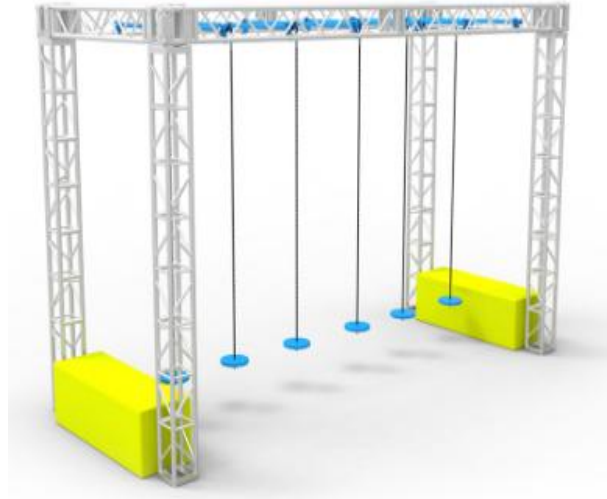

## DIFFICULTY

NOVICE

INTERMEDIATE

EXPERT

## AGE

KID

TEEN

ADULT

## FOCUS

BALANCE

LOWER

UPPER

<b>Code</b>	FS-30
<b>Adapted Frame</b>	2*5M
<b>Truss Frame</b>	Not Include
<b>Foam</b>	Not Include

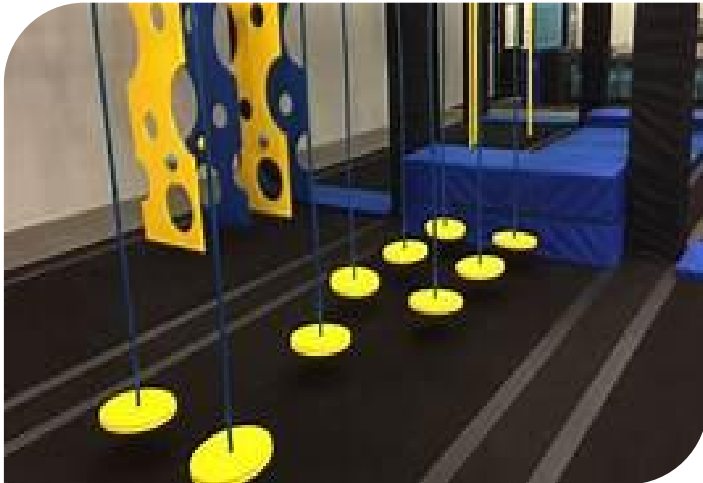



# Wing Nut

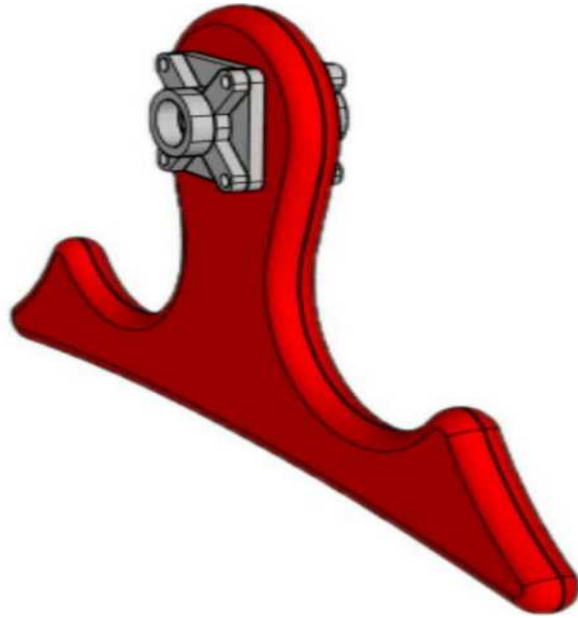

### DIFFICULTY

NOVICE INTERMEDIATE **EXPERT**

### AGE

KID **TEEN** ADULT

### FOCUS

BALANCE LOWER **UPPER**

Code	FS-31
Adapted Frame	2*5M
Truss Frame	Not Include
Foam	Not Include







# Sea of Multiple

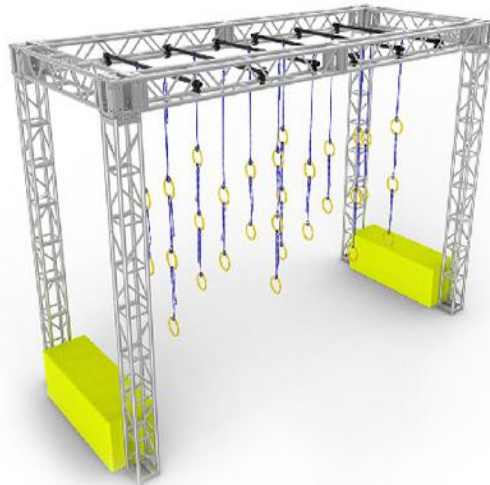

## DIFFICULTY

NOVICE

INTERMEDIATE

EXPERT

## AGE

KID

TEEN

ADULT

## FOCUS

BALANCE

LOWER

UPPER

<b>Code</b>	FS-32
<b>Adapted Frame</b>	2*5M
<b>Truss Frame</b>	Not Include
<b>Foam</b>	Not Include



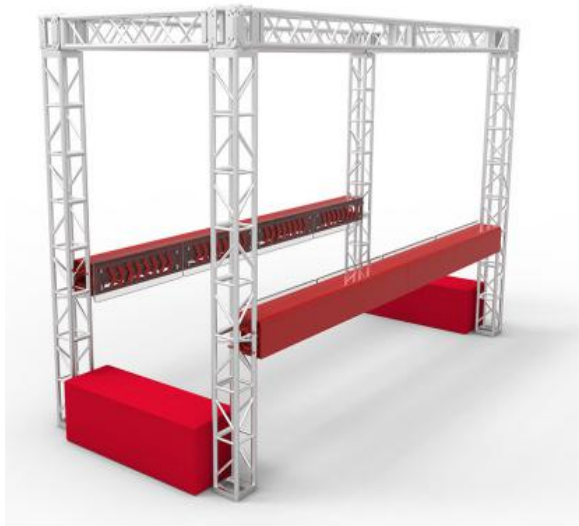

#### DIFFICULTY

NOVICE

INTERMEDIATE

EXPERT

#### AGE

KID

TEEN

ADULT

#### FOCUS

BALANCE

LOWER

UPPER

# Plank Traverse

<b>Code</b>	FS-33
<b>Adapted Frame</b>	2*5M
<b>Truss Frame</b>	Not Include
<b>Foam</b>	Not Include







# Cargo Bag

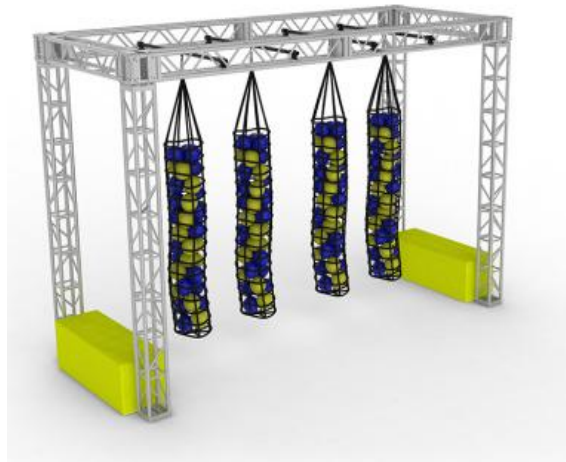

## DIFFICULTY

NOVICE

INTERMEDIATE

EXPERT

## AGE

KID

TEEN

ADULT

## FOCUS

BALANCE

LOWER

UPPER

<b>Code</b>	FS-34
<b>Adapted Frame</b>	2*5M
<b>Truss Frame</b>	Not Include
<b>Foam</b>	Not Include





**NINJA  
WARRIOR  
DESIGN**

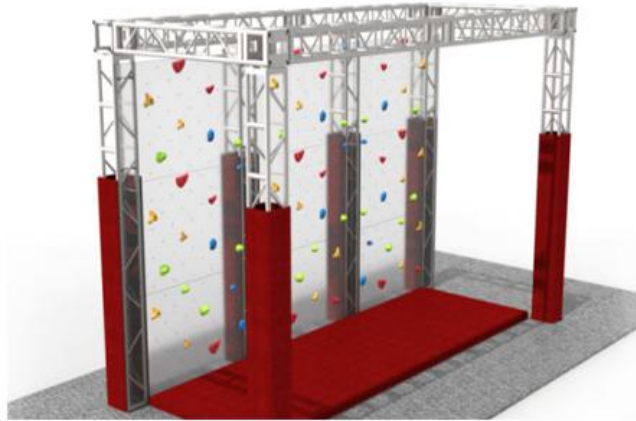

#### DIFFICULTY

NOVICE

INTERMEDIATE

EXPERT

#### AGE

KID

TEEN

ADULT

#### FOCUS

BALANCE

LOWER

UPPER

# Climbing Wall

<b>Code</b>	FS-35
<b>Adapted Frame</b>	2*6M
<b>Truss Frame</b>	Not Include
<b>Foam</b>	Not Include







**NINJA  
WARRIOR  
DESIGN**



**DIFFICULTY**

NOVICE INTERMEDIATE **EXPERT**

**AGE**

KID **TEEN** ADULT

**FOCUS**

BALANCE **LOWER** UPPER

# Spider Jump-A

<b>Code</b>	FS-36
<b>Adapted Frame</b>	2*6M
<b>Truss Frame</b>	Not Include
<b>Foam</b>	Not Include

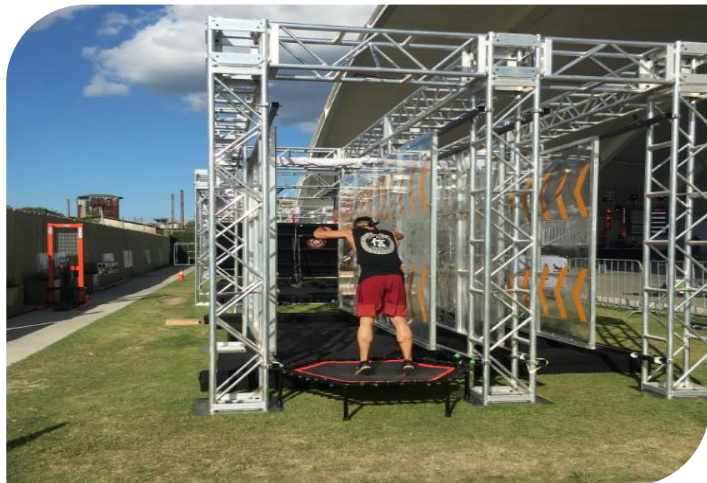



# Floating Bridge

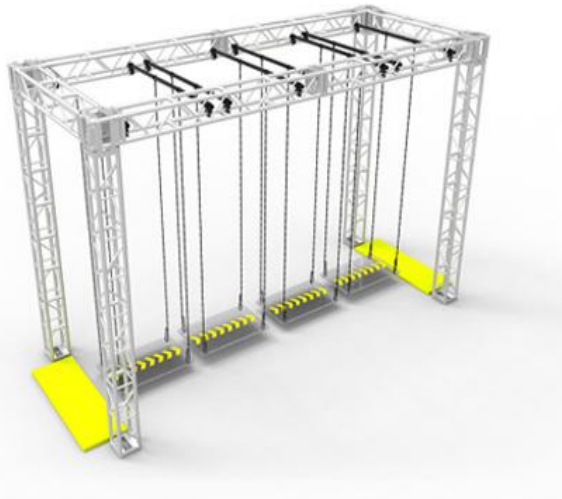

### DIFFICULTY

- NOVICE
- INTERMEDIATE**
- EXPERT

### AGE

- KID
- TEEN**
- ADULT

### FOCUS

- BALANCE**
- LOWER
- UPPER

<b>Code</b>	FS-37
<b>Adapted Frame</b>	2*5M
<b>Truss Frame</b>	Not Include
<b>Foam</b>	Not Include







# Sea of Ring - High



### DIFFICULTY

- NOVICE
- INTERMEDIATE**
- EXPERT

### AGE

- KID**
- TEEN
- ADULT

### FOCUS

- BALANCE
- LOWER
- UPPER**

<b>Code</b>	FS-38
<b>Adapted Frame</b>	2*5M
<b>Truss Frame</b>	Not Include
<b>Foam</b>	Not Include





# Sea of Ring Low

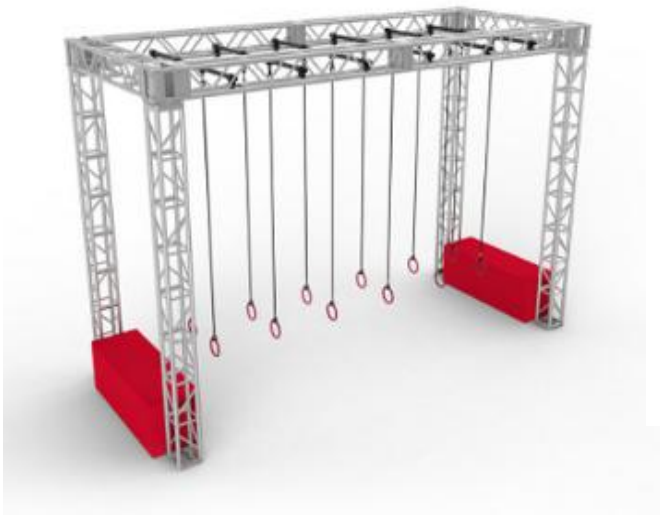

### DIFFICULTY

- NOVICE
- INTERMEDIATE
- EXPERT

### AGE

- KID
- TEEN
- ADULT

### FOCUS

- BALANCE
- LOWER
- UPPER

<b>Code</b>	FS-39
<b>Adapted Frame</b>	2*5M
<b>Truss Frame</b>	Not Include
<b>Foam</b>	Not Include







**NINJA  
WARRIOR  
DESIGN**

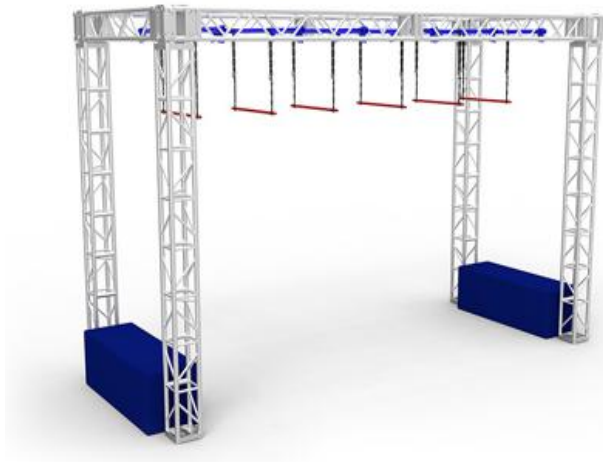

**DIFFICULTY**

NOVICE

**INTERMEDIATE**

EXPERT

**AGE**

KID

**TEEN**

ADULT

**FOCUS**

BALANCE

LOWER

**UPPER**

# Trapeze Bar

<b>Code</b>	FS-40
<b>Adapted Frame</b>	2*5M
<b>Truss Frame</b>	Not Include
<b>Foam</b>	Not Include





# Sea of Swings

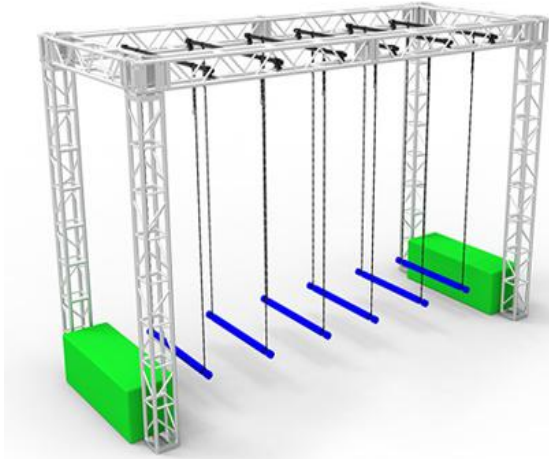

## DIFFICULTY

- NOVICE**
- INTERMEDIATE
- EXPERT

## AGE

- KID**
- TEEN
- ADULT

## FOCUS

- BALANCE
- LOWER**
- UPPER

<b>Code</b>	FS-41
<b>Adapted Frame</b>	2*5M
<b>Truss Frame</b>	Not Include
<b>Foam</b>	Not Include







# Rope Swing to Cargo

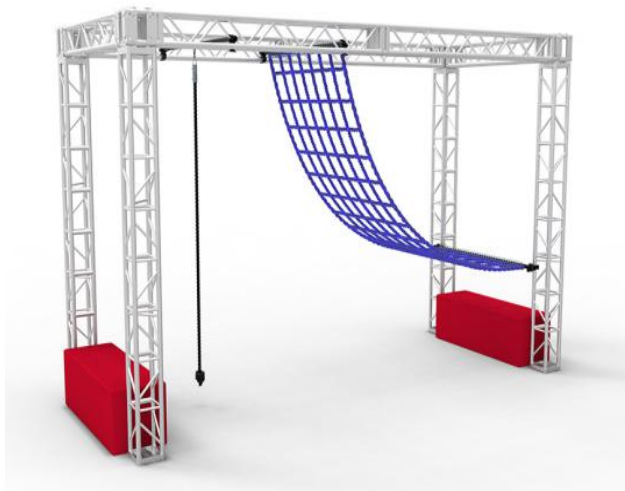

### DIFFICULTY

- NOVICE
- INTERMEDIATE
- EXPERT

### AGE

- KID
- TEEN
- ADULT

### FOCUS

- BALANCE
- LOWER
- UPPER

<b>Code</b>	FS-42
<b>Adapted Frame</b>	2*5M
<b>Truss Frame</b>	Not Include
<b>Foam</b>	Not Include



# Broken Bridge

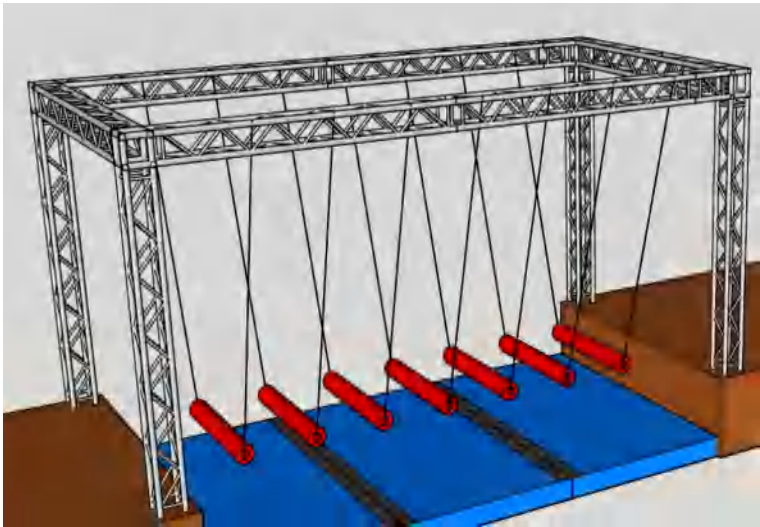

**DIFFICULTY**

NOVICE
  INTERMEDIATE
  EXPERT

**AGE**

KID
  TEEN
  ADULT

**FOCUS**

BALANCE
  LOWER
  UPPER

<b>Code</b>	FS-43
<b>Adapted Frame</b>	2*5M
<b>Truss Frame</b>	Not Include
<b>Foam</b>	Not Include







# Sea of Poles with

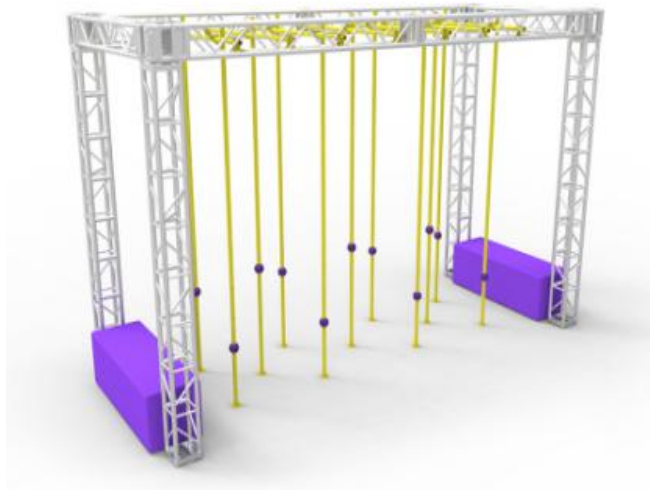

## DIFFICULTY

NOVICE

INTERMEDIATE

EXPERT

## AGE

KID

TEEN

ADULT

## FOCUS

BALANCE

LOWER

UPPER

<b>Code</b>	FS-44
<b>Adapted Frame</b>	2*5M
<b>Truss Frame</b>	Not Include
<b>Foam</b>	Not Include





#### DIFFICULTY

NOVICE

INTERMEDIATE

EXPERT

#### AGE

KID

TEEN

ADULT

#### FOCUS

BALANCE

LOWER

UPPER

# Twisty

Code	FS-45
Adapted Frame	2*5M
Truss Frame	Not Include
Foam	Not Include





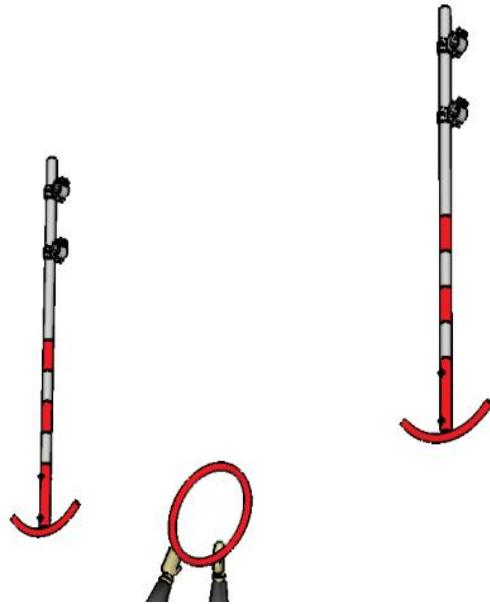

#### DIFFICULTY

NOVICE

INTERMEDIATE

EXPERT

#### AGE

KID

TEEN

ADULT

#### FOCUS

BALANCE

LOWER

UPPER

# Fly Hook

Code	FS-46
Adapted Frame	2*5M
Truss Frame	Not Include
Foam	Not Include





TUV NORD  
EN 1090-1, -3

NINJA  
WARRIOR  
DESIGN



#### DIFFICULTY

NOVICE

INTERMEDIATE

EXPERT

#### AGE

KID

TEEN

ADULT

#### FOCUS

BALANCE

LOWER

UPPER

## Ring Swing

Code	FS-47
Adapted Frame	2*5M
Truss Frame	Not Include
Foam	Not Include







#### DIFFICULTY

NOVICE

INTERMEDIATE

EXPERT

#### AGE

KID

TEEN

ADULT

#### FOCUS

BALANCE

LOWER

UPPER

# Fly Wheel

Code	FS-48
Common Need	3 Pcs
Truss Frame	Not Include
Foam	Not Include

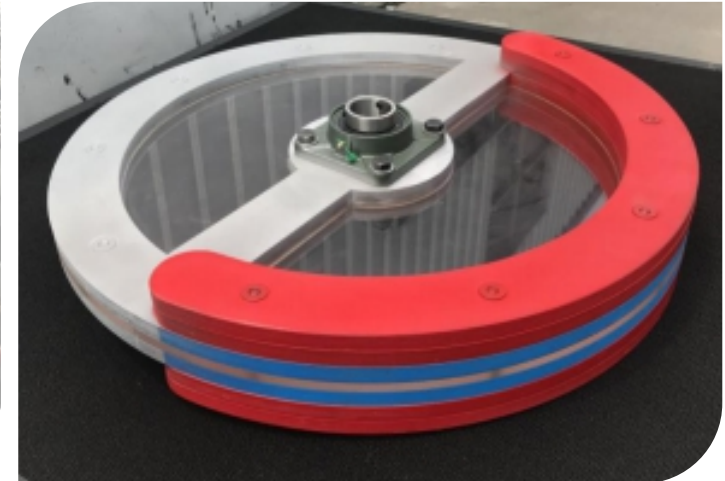



# Flying Bar

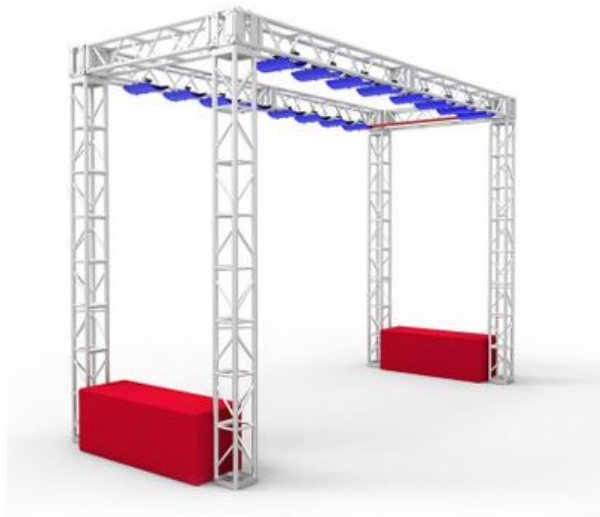

### DIFFICULTY

- NOVICE
- INTERMEDIATE
- EXPERT**

### AGE

- KID
- TEEN
- ADULT**

### FOCUS

- BALANCE
- LOWER
- UPPER**

<b>Code</b>	FS-49
<b>Adapted Frame</b>	2*5M
<b>Truss Frame</b>	Not Include
<b>Foam</b>	Not Include

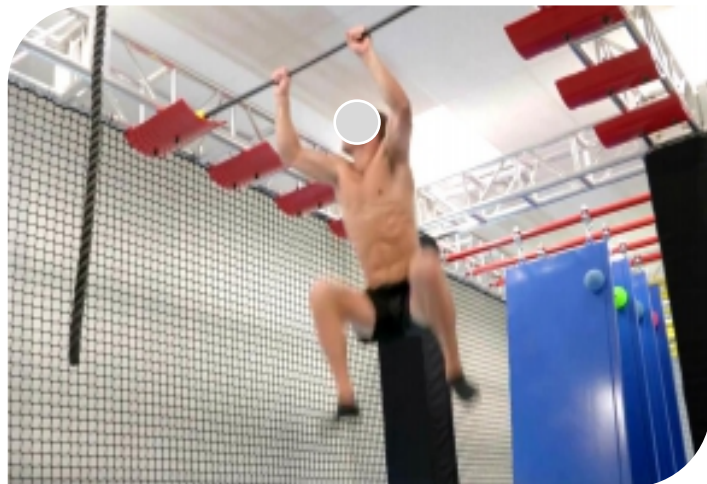





**NINJA  
WARRIOR  
DESIGN**

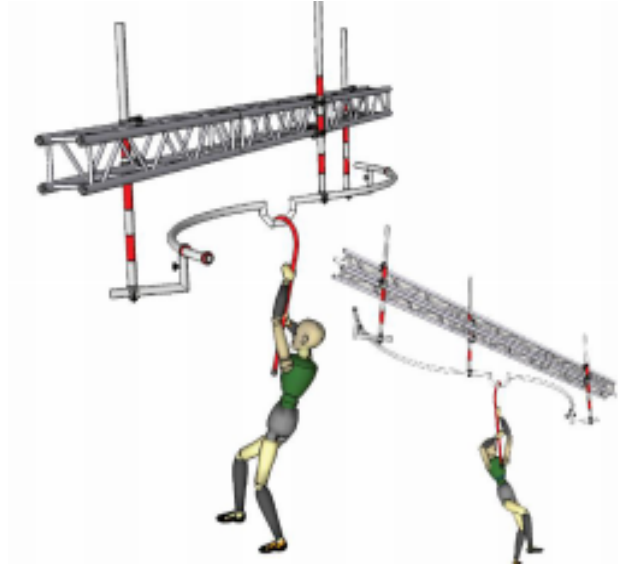

**DIFFICULTY**

NOVICE INTERMEDIATE **EXPERT**

**AGE**

KID **TEEN** ADULT

**FOCUS**

BALANCE LOWER **UPPER**

# Cane Hopper

<b>Code</b>	FS-50
<b>Adapted Frame</b>	2*5M
<b>Truss Frame</b>	Not Include
<b>Foam</b>	Not Include



# Single Helix

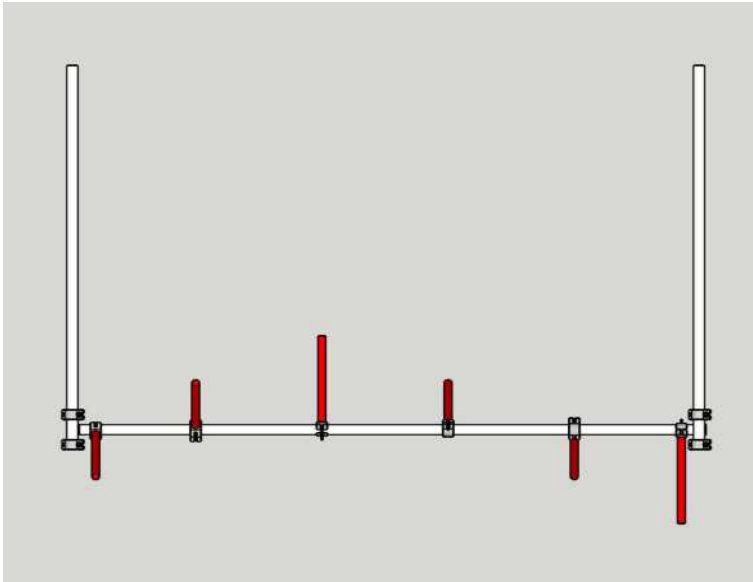

**DIFFICULTY**

**AGE**

**FOCUS**

<b>Code</b>	FS-51
<b>Adapted Frame</b>	2*5M
<b>Truss Frame</b>	Not Include
<b>Foam</b>	Not Include

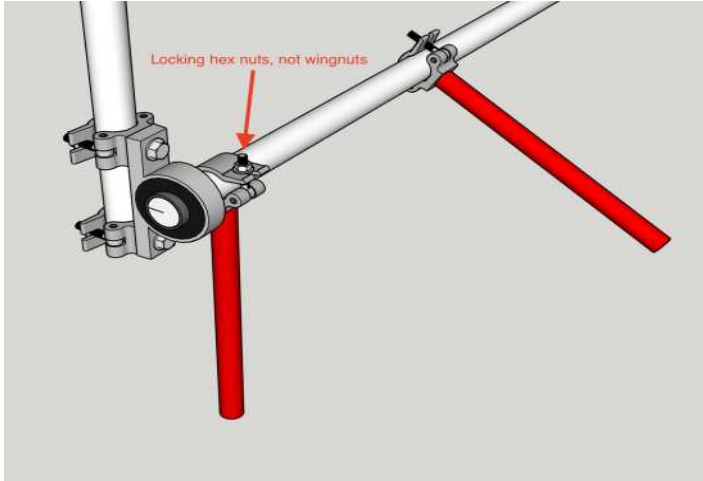
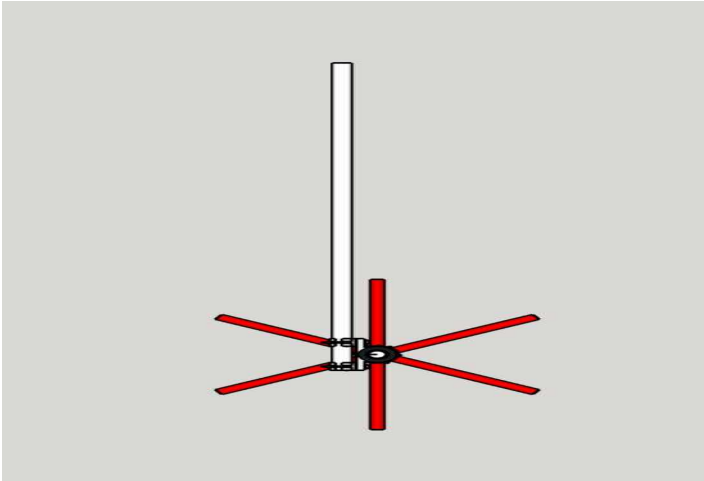
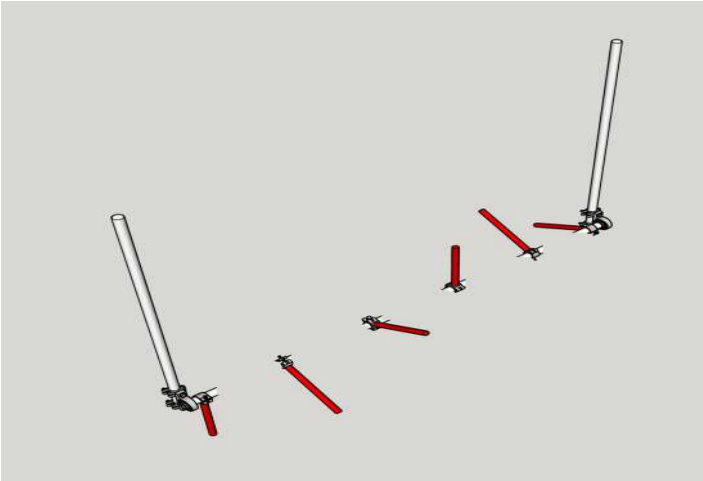





**NINJA  
WARRIOR  
DESIGN**

# Lightning Bolt

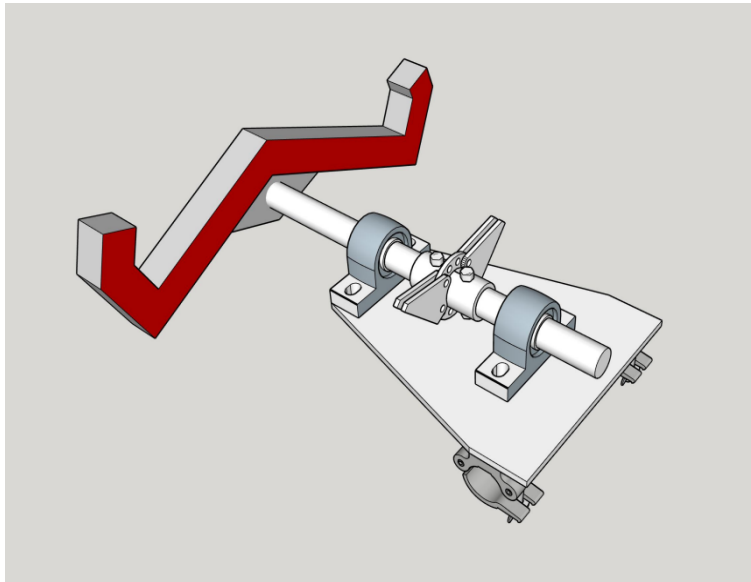

## DIFFICULTY

NOVICE

INTERMEDIATE

**EXPERT**

## AGE

KID

**TEEN**

ADULT

## FOCUS

BALANCE

LOWER

**UPPER**

<b>Code</b>	FS-52
<b>Adapted Frame</b>	2*5M
<b>Truss Frame</b>	Not Include
<b>Foam</b>	Not Include

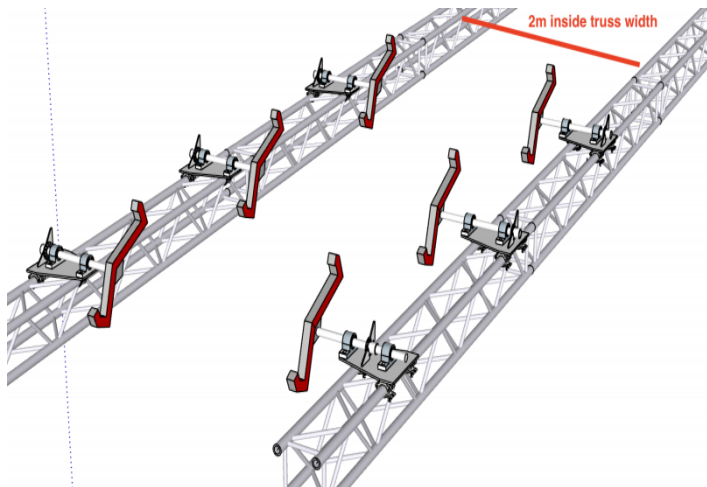

# Floating Monkey Bar

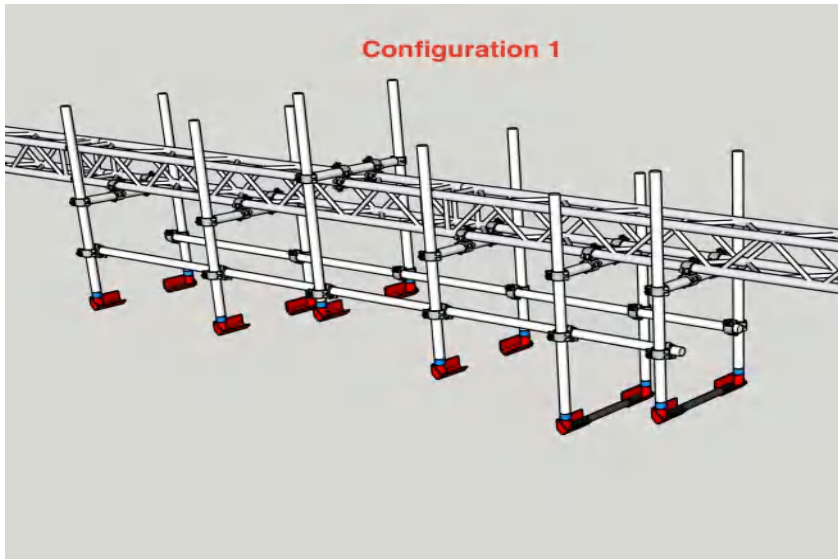

## DIFFICULTY

- NOVICE
- INTERMEDIATE
- EXPERT**

## AGE

- KID
- TEEN**
- ADULT

## FOCUS

- BALANCE
- LOWER
- UPPER**

<b>Code</b>	FS-53
<b>Adapted Frame</b>	2*5M
<b>Truss Frame</b>	Not Include
<b>Foam</b>	Not Include

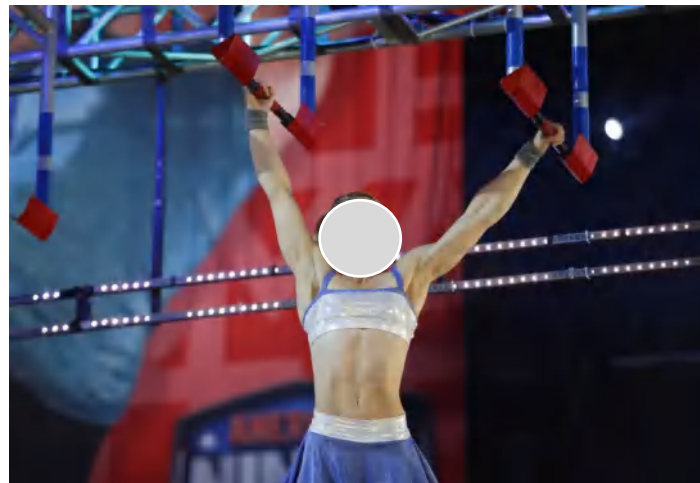
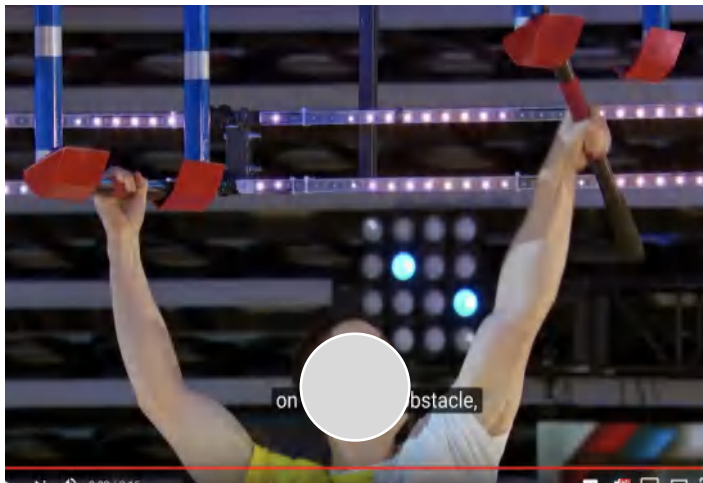





**TUV NORD**  
EN 1090-1, -3

**NINJA WARRIOR**  
DESIGN

# Cliff Hanger

One Cliffhanger Set (two 1m and two 0.5m)

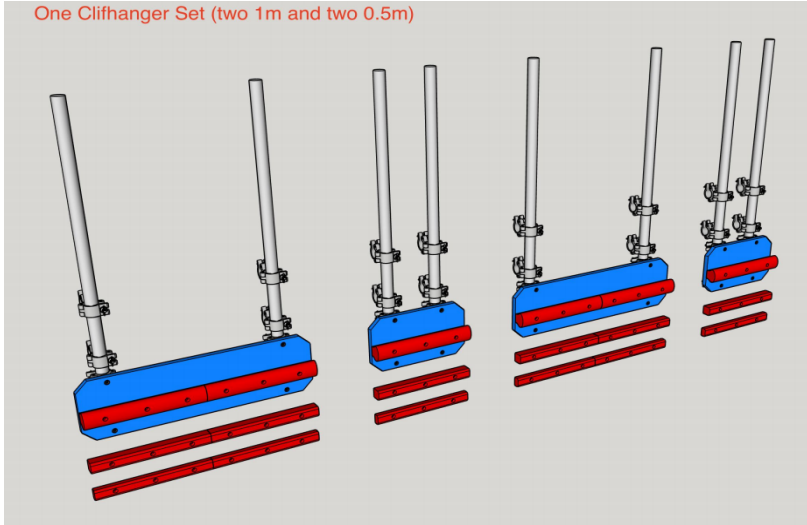

### DIFFICULTY

- NOVICE
- INTERMEDIATE
- EXPERT**

### AGE

- KID
- TEEN**
- ADULT

### FOCUS

- BALANCE
- LOWER
- UPPER**

<b>Code</b>	FS-54
<b>Adapted Frame</b>	2*5M
<b>Truss Frame</b>	Not Include
<b>Foam</b>	Not Include

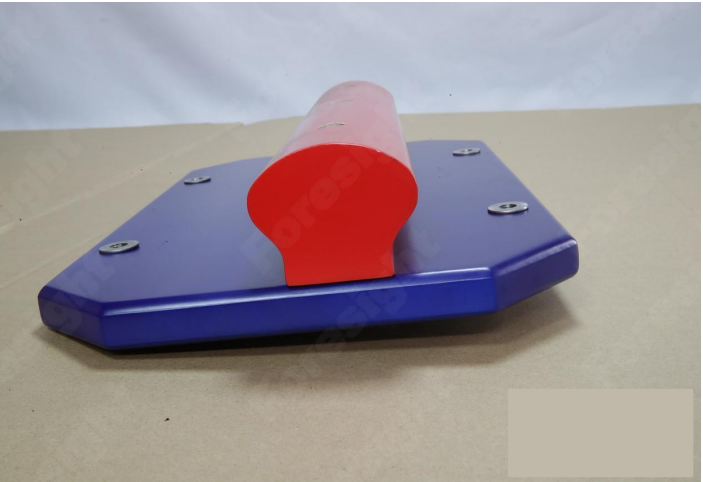
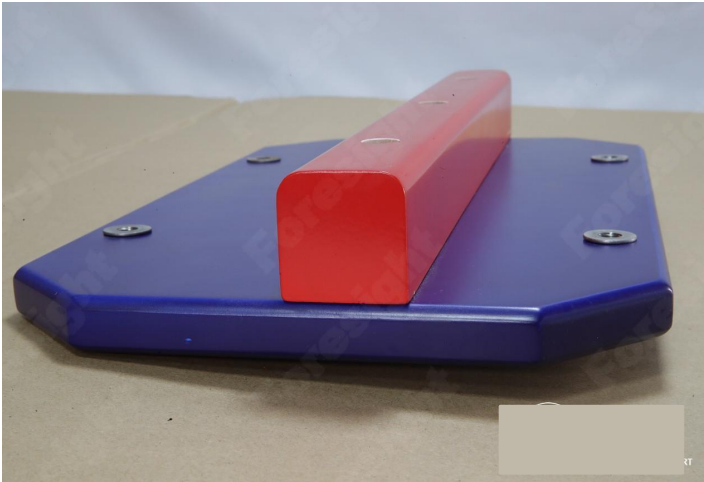
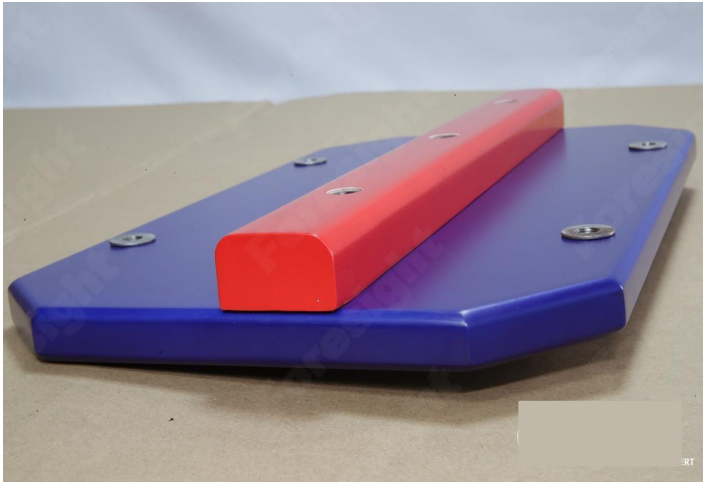



**Shenzhen Good Equipment Co., Ltd.**

**ADD:Room 422, 4th Floor, Gaofeng Community, Dalang Street,  
Longhua District, Shenzhen, Guangdong, China 518110**

**[www.szgoodequipment.com](http://www.szgoodequipment.com)**

